

## ROTARY VANE PUMPS AND CHEMISTRY-HYBRID PUMPS

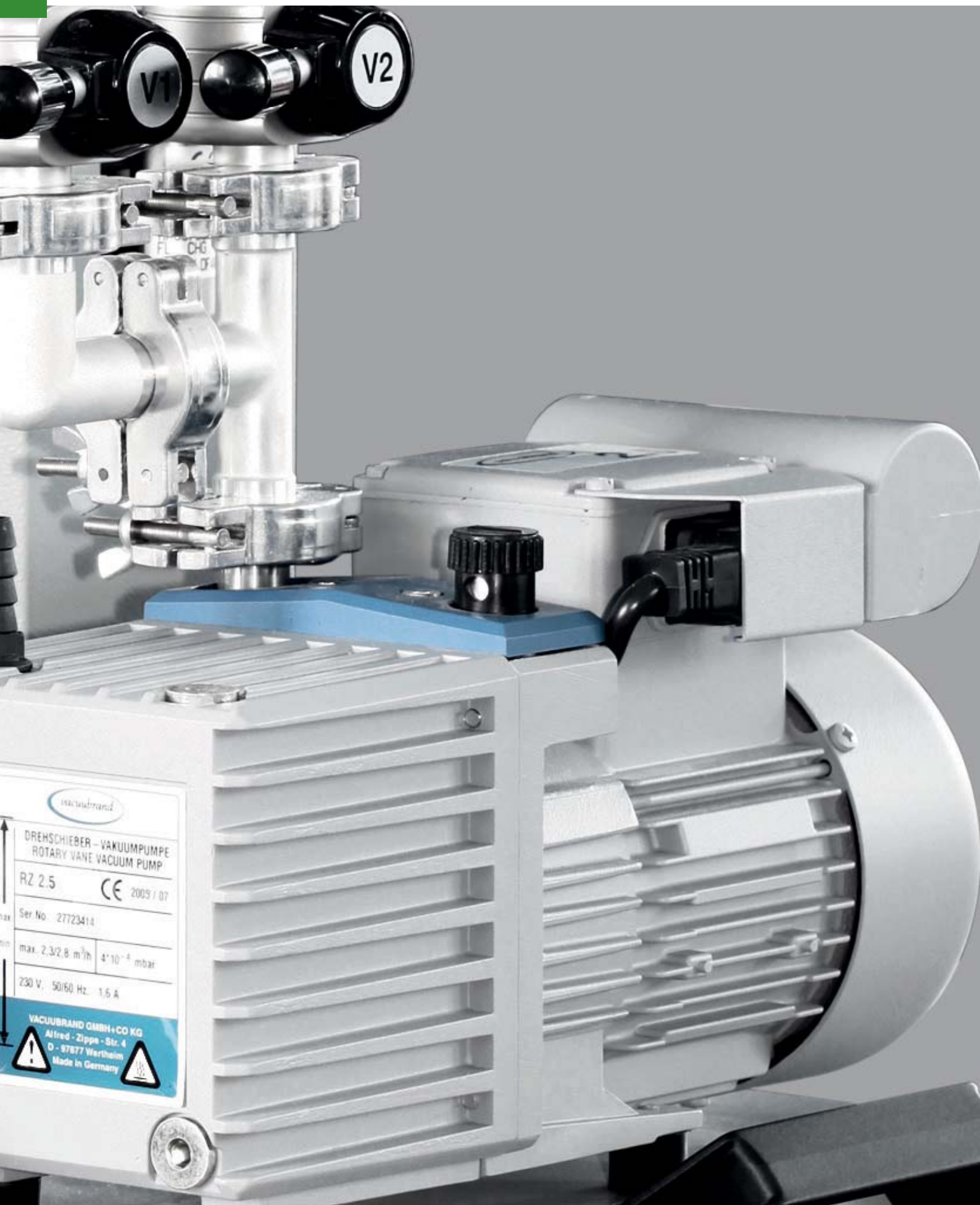

---

## ROTARY VANE PUMPS AND PUMPING UNITS AND CHEMISTRY-HYBRID PUMPS

Rotary vane pumps are used whenever it is necessary to have a process vacuum of up to  $10^{-3}$  mbar. VACUUBRAND rotary vane pumps are high-performance, yet compact, and can be equipped with an extensive line of VACUUBRAND accessories. They have an innovative lubrication system with a built-in oil pump and have a large oil volume. This extends oil change and service intervals and protects the pump at start-up. The effective gas ballast feature, with its high-flow gas ballast, provides high vapor pumping capability for water and solvents. VACUUBRAND rotary vane pumps' volume flow rate is specified at atmospheric pressure, as is customary with PNEUROP®. For process efficiency, however, the high volume flow rate of VACUUBRAND pumps under process conditions, as well as a consistently high volume flow rate over a wide pressure range, is the key to your satisfaction in real-world application. After switch-off the aggregate is vacuum-sealed to protect your application from undesired venting and oil back flow.

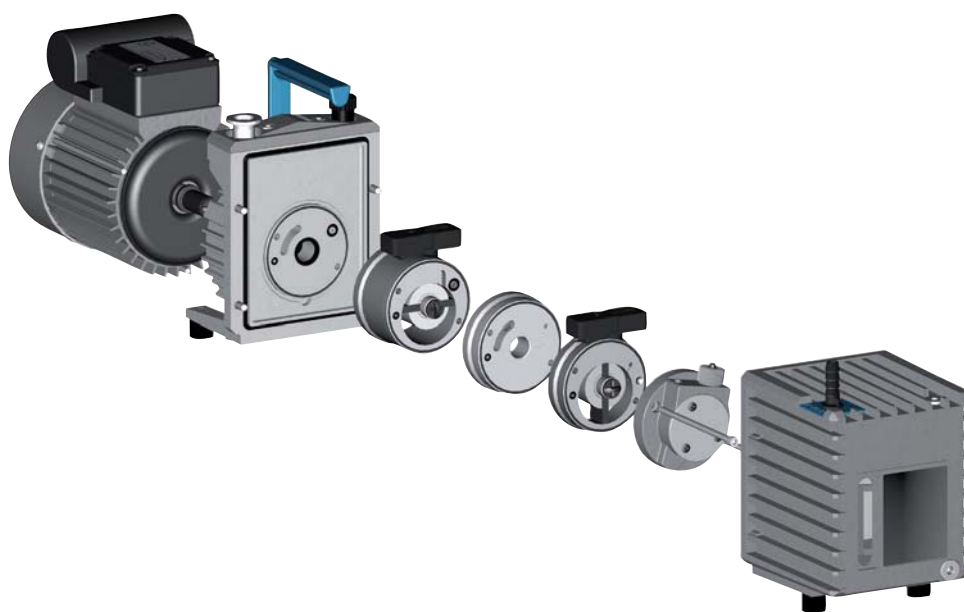

- ◆ constriction-free vapor pathway allows high volume flow rates, even when close to the ultimate vacuum
  - ◆ high tolerance for water and solvent vapors, because of the high-volume gas ballast
  - ◆ quiet running and excellent ultimate vacuum, even with gas ballast
  - ◆ active corrosion protection: Oil cycle closes vacuum-tight against the intake of corrosive gases and oil impurities into the reservoir when shut down
  - ◆ lubrication circuit, and large usable oil volume provides extended oil change and service intervals
  - ◆ compact design, low weight and easy service due to telescopic design
-

## ROTARY VANE PUMPS AND CHEMISTRY-HYBRID PUMPS

The rotary vane pumps from VACUUBRAND are especially designed for use in chemistry and physics. The powerful gas ballast system helps to prevent condensation inside the pump. Simultaneously the pumps are reaching an outstanding ultimate vacuum even with open gas ballast valve. Rotary vane pumping systems from VACUUBRAND are suggested for applications in the fine vacuum range that demand special precautions to protect the pump and environment. The PC 3 pumping units with two-stage rotary vane pump (RZ 2.5 through RZ 9) have an inlet-side glass cold trap, exhaust oil mist filter and the accessories needed to handle larger amounts of condensable vapors. The RC 6 chemistry-HYBRID pump is the combination of a two-stage rotary vane pump and a chemistry diaphragm pump made of corrosion-resistant materials. By reducing solvent condensation and continuously distilling trapped solvents out of the pump oil the RC 6 offers the service advantages of an oil-free chemistry pump with the low ultimate vacuum of a two-stage rotary vane pump.

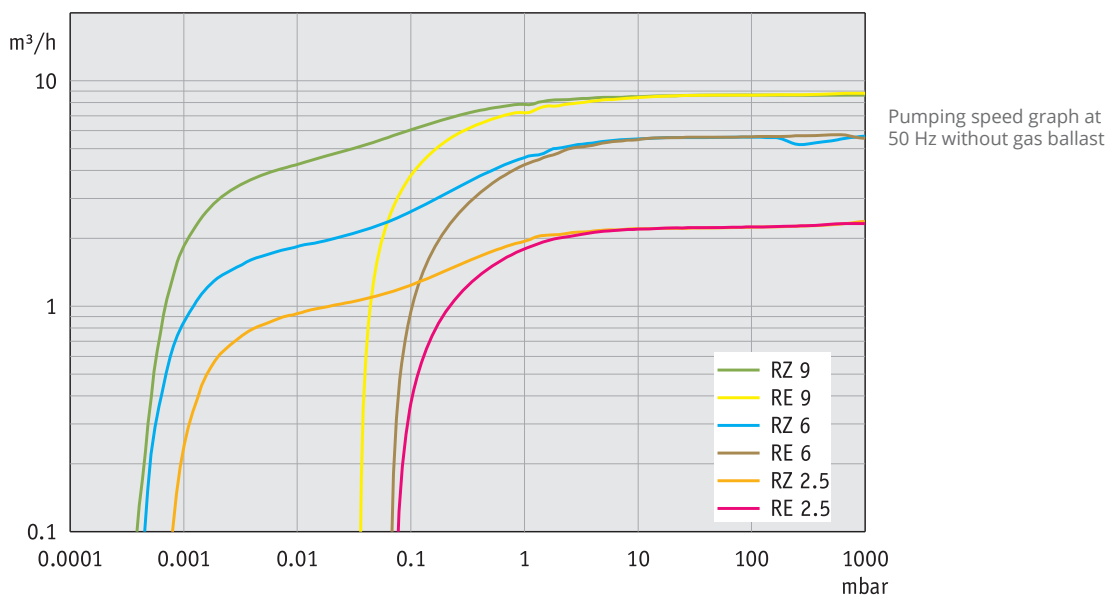

Further information and diagrams for 60 Hz mains frequency at [www.vacuubrand.com](http://www.vacuubrand.com)  
Pumping speeds and pump down times are only for information. Ultimate vacuum specification: See "Technical Data"

## 7 GOLDEN RULES WHEN USING OIL-SEALED ROTARY VANE PUMPS

- ◆ Before use, warm up pump with inlet blocked to reduce condensation in pump
- ◆ Avoid particles to protect mechanical parts
- ◆ Never block pump outlet
- ◆ Use gas ballast to purge condensable vapors
- ◆ Use a cold trap to protect pump from corrosive and condensable vapors
- ◆ After application is complete, run pump a few minutes with inlet blocked and gas ballast open to purge solvents from pump
- ◆ Check oil and maintain regularly

There are expedient hands-on packages available as a system solution with an exhaust oil mist filter (with built-in safety overpressure valve) and a manual in-line valve, e.g. to warm up the pump. There is also a package available with an additional VACUU-VIEW extended fine vacuum gauge.

SERIES OVERVIEW



<b>Attainable ultimate vacuum</b>	<b>Series overview RE / RZ</b>	<b>Pumping unit PC 3</b>	<b>Package solutions down to 2x10<sup>-3</sup> mbar</b>	<b>Chemistry-HYBRID pumps</b>
<b>down to 2x10<sup>-1</sup> mbar</b>	<b>RE 2.5</b> ..... pg. 144 2.3 m <sup>3</sup> /h <b>RE 6</b> ..... pg. 146 5.7 m <sup>3</sup> /h <b>RE 9</b> ..... pg. 148 8.9 m <sup>3</sup> /h			

<b>down to 2x10<sup>-3</sup> mbar</b>	<b>RZ 2.5</b> ..... pg. 144 2.3 m <sup>3</sup> /h <b>RZ 6</b> ..... pg. 146 5.7 m <sup>3</sup> /h <b>RZ 9</b> ..... pg. 148 8.9 m <sup>3</sup> /h	<b>PC 3 / RZ 2.5</b> ..... pg. 144 2.3 m <sup>3</sup> /h <b>PC 3 / RZ 6</b> ..... pg. 146 5.7 m <sup>3</sup> /h <b>PC 3 / RZ 9</b> ..... pg. 148 8.9 m <sup>3</sup> /h	<b>RZ 2.5 +FO +VS 16</b> ..... pg. 144 2.3 m <sup>3</sup> /h <b>RZ 6 +FO +VS 16</b> ..... pg. 146 5.7 m <sup>3</sup> /h <b>RZ 6 +FO +VS 16 +VACUU-VIEW extended</b> ..... pg. 147 5.7 m <sup>3</sup> /h	<b>RC 6</b> ..... pg. 150 5.9 m <sup>3</sup> /h <b>PC 8 / RC 6</b> ..... pg. 150 5.9 m <sup>3</sup> /h
---------------------------------------	--	---	--	---



<b>Page</b>	pg. 152	pg. 155	pg. 154	pg. 180
-------------	---------	---------	---------	---------



<b>Page</b>	pg. 156	pg. 197	pg. 202
-------------	---------	---------	---------

- ◆ high flow rates even at vacuum levels approaching ultimate vacuum
- ◆ high water vapor tolerance due to efficient gas ballast; very good ultimate vacuum even with gas ballast
- ◆ vacuum-tight at switch-off; external anti-suckback valve not needed
- ◆ large oil volume: Long intervals between oil changes
- ◆ ease of maintenance due to telescopic design



RE 2.5 - RZ 2.5 - PUMPING UNIT PC 3 WITH RZ 2.5

The one-stage RE 2.5 and two-stage RZ 2.5 are high-performance rotary vane pumps with extra compact design and low weight. They are the ideal solution for a wide range of laboratory and process applications that require low ultimate vacuum at medium gas flow rate. The rotary vane pumping unit PC 3 with cold trap (GKF 1000i) at the inlet helps the pump to handle larger volumes of condensable vapors. The pumping unit is compact, user-friendly, and well-arranged, with oil mist filter at the outlet, a valve, and a T-connection for a gauge. The RZ 2.5 is also available combined with the oil mist filter (FO) and the VS 16 valve as a package.

Pumping speed graph at 50 Hz with/without gas ballast

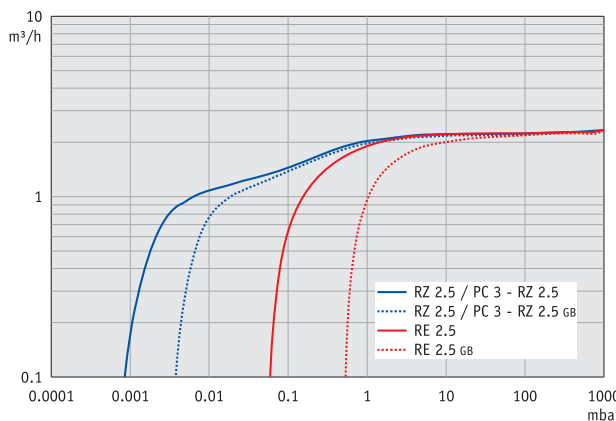

Pump down graph at 50 Hz with/without gas ballast (10 l volume)

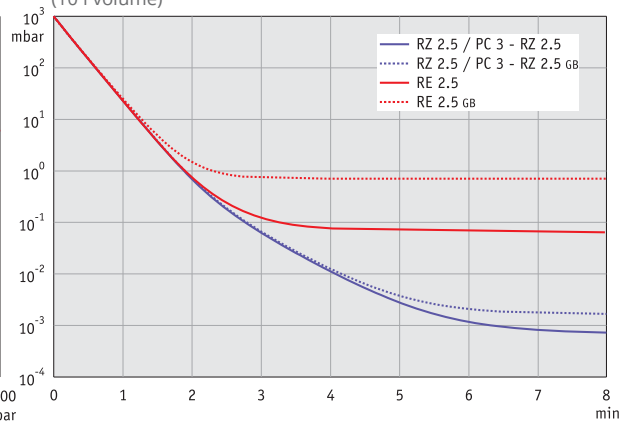

Further information and diagrams for 60 Hz mains frequency at [www.vacuubrand.com](http://www.vacuubrand.com)  
 Pumping speeds and pump down times are only for information. Ultimate vacuum specification: See "Technical Data"

---

 ROTARY VANE PUMPS AND CHEMISTRY-HYBRID PUMPS
 

---

TECHNICAL DATA	RE 2.5	RZ 2.5
Number of stages	1	2
Max. pumping speed at 50/60 Hz	2.3 / 2.8 m <sup>3</sup> /h	2.3 / 2.8 m <sup>3</sup> /h
Ultimate partial vacuum (abs.)	3 x 10 <sup>-1</sup> mbar	4 x 10 <sup>-4</sup> mbar
Ultimate vacuum (abs.)	3 x 10 <sup>-1</sup> mbar	2 x 10 <sup>-3</sup> mbar
Ultim. vac. (abs.) with gas ballast	8 x 10 <sup>-1</sup> mbar	1 x 10 <sup>-2</sup> mbar
Water vapor tolerance with gas ballast	40 mbar	40 mbar
Oil capacity (B-Oil) min./max.	0.18 / 0.51 l	0.1 / 0.28 l
Inlet connection	Small flange KF DN 16	Small flange KF DN 16
Outlet connection	Hose nozzle DN 8-10 mm	Hose nozzle DN 8-10 mm
Rated motor power	0.18 kW	0.18 kW
Rated motor speed at 50/60 Hz	1500/1800	1500/1800
Degree of protection	IP 40	IP 40
Dimensions (L x W x H), approx.	316 x 125 x 190 mm	316 x 125 x 190 mm
Weight, approx.	10.2 kg	11.4 kg

ORDERING INFORMATION	RE 2.5
230 V ~ 50-60 Hz CEE	697150
230 V ~ 50-60 Hz CH, CN	697151
230 V ~ 50-60 Hz UK, IN	697152
100-115 V ~ 50-60 Hz / 120 V ~ 60 Hz	
200-230 V ~ 50-60 Hz* US	**697156

**RE 2.5, RZ 2.5 + PERFLUOROPOLYETHER OIL**

 on request
 

---

ORDERING INFORMATION	RZ 2.5
230 V ~ 50-60 Hz CEE	698120
230 V ~ 50-60 Hz CH	698121
230 V ~ 50-60 Hz UK, IN	698122
230 V ~ 50-60 Hz CEE/CN	698127
100-115 V ~ 50-60 Hz / 120 V ~ 60 Hz	
200-230 V ~ 50-60 Hz* US	**698126

ORDERING INFORMATION	PC 3 / RZ 2.5
230 V ~ 50-60 Hz CEE	699890

ORDERING INFORMATION	RZ 2.5 +FO +VS 16
230 V ~ 50-60 Hz CEE	698029

**ACCESSORIES**

Stainless steel tubing KF DN 16 (1000 mm: 673336)  
 Separator inlet side AK R 2/2.5 (698000)  
 Oil mist filter FO R 2/2.5/5/6 (698003)  
 Package fine vacuum control KF DN 16 (683201)  
 Rubber vacuum tubing DN 8 mm (686001)  
 Small flange KF DN 16 with hose nozzle DN 8-10 mm (662806)

**ITEMS SUPPLIED**

Pump oil filled and completely mounted, ready for use, with manual.

\* With NRTL certification for Canada and the USA

\*\* Country specific power cable, please order separately if needed



- ✦ high flow rates even at vacuum levels approaching ultimate vacuum
- ✦ high water vapor tolerance due to efficient gas ballast; very good ultimate vacuum even with gas ballast
- ✦ vacuum-tight at switch-off; external anti-suckback valve not needed
- ✦ large oil volume: Long intervals between oil changes
- ✦ ease of maintenance due to telescopic design



### RE 6 - RZ 6 - PUMPING UNIT PC 3 WITH RZ 6

These powerful rotary vane pumps feature a particularly compact design and low weight for pumps of this capacity. They are the ideal solution for a wide range of laboratory and process applications that require low ultimate vacuum at medium to increased gas flow rate. The PC 3 rotary vane pumping unit, with GKF 1000i cold trap at the inlet, helps the pump to handle large amounts of condensable vapors. The PC 3 pumping unit is compact, user-friendly and well-arranged, with an oil mist filter at the outlet, a valve and a T-connection for a gauge. Various packages including pump, oil mist filter, etc. are available.

Pumping speed graph at 50 Hz  
with/without gas ballast

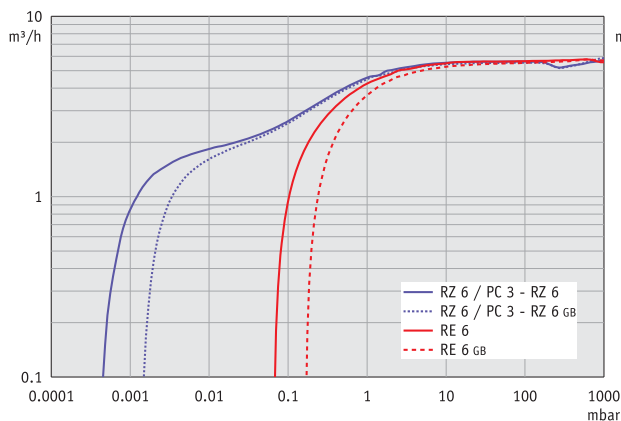

Pump down graph at 50 Hz  
with/without gas ballast  
(10 l volume)

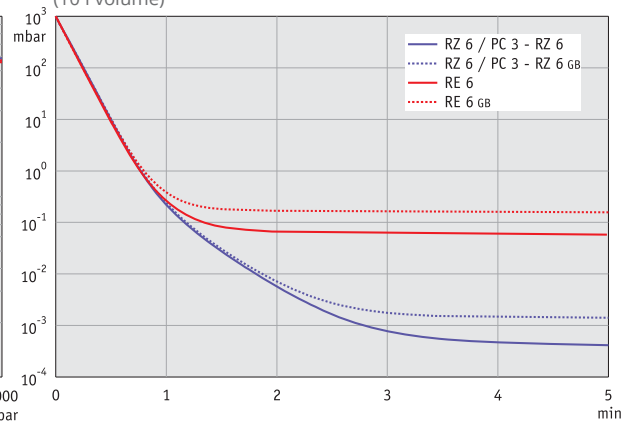

---

 ROTARY VANE PUMPS AND CHEMISTRY-HYBRID PUMPS
 

---

TECHNICAL DATA	RE 6	RZ 6
Number of stages	1	2
Max. pumping speed at 50/60 Hz	5.7 / 6.8 m <sup>3</sup> /h	5.7 / 6.8 m <sup>3</sup> /h
Ultimate partial vacuum (abs.)	1 x 10 <sup>-1</sup> mbar	4 x 10 <sup>-4</sup> mbar
Ultimate vacuum (abs.)	1 x 10 <sup>-1</sup> mbar	2 x 10 <sup>-3</sup> mbar
Ultim. vac. (abs.) with gas ballast	6 x 10 <sup>-1</sup> mbar	1 x 10 <sup>-2</sup> mbar
Water vapor tolerance with gas ballast	40 mbar	40 mbar
Oil capacity (B-Oil) min./max.	0.36 / 0.93 l	0.34 / 0.73 l
Inlet connection	Small flange KF DN 16	Small flange KF DN 16
Outlet connection	Hose nozzle DN 8-10 mm	Hose nozzle DN 8-10 mm
Rated motor power	0.3 kW	0.3 kW
Rated motor speed at 50/60 Hz	1500/1800	1500/1800
Degree of protection	IP 40	IP 40
Dimensions (L x W x H), approx.	370 x 142 x 207 mm	370 x 142 x 207 mm
Weight, approx.	15.4 kg	16.4 kg

ORDERING INFORMATION		RE 6
230 V ~ 50-60 Hz	CEE	697160
230 V ~ 50-60 Hz	CH, CN	697161
230 V ~ 50-60 Hz	UK, IN	697162
100-120 V ~ 50-60 Hz /		
200-230 V ~ 50-60 Hz*	US	**697166

ORDERING INFORMATION		PACKAGES FOR ROTARY VANE PUMPS
<b>RZ 6 +FO +VS 16</b>		
230 V ~ 50-60 Hz	CEE	698039
230 V ~ 50-60 Hz	CH, CN	698009
230 V ~ 50-60 Hz	UK	698059

**RE 6, RZ 6 + PERFLUOROPOLYETHER OIL**

on request

**RZ 6 +FO +VS 16 +VACUU-VIEW EXTENDED**

230 V ~ 50-60 Hz	CEE	698160
230 V ~ 50-60 Hz	CH, CN	698161

ORDERING INFORMATION		RZ 6
230 V ~ 50-60 Hz	CEE	698130
230 V ~ 50-60 Hz	CH	698131
230 V ~ 50-60 Hz	UK, IN	698132
400 V ~ 50 Hz 3 Ph.	CEE	698135
230 V ~ 50-60 Hz	CEE/CN	698138
100-120 V ~ 50-60 Hz /		
200-230 V ~ 50-60 Hz*	US	**698136

**ACCESSORIES**

Stainless steel tubing KF DN 16 (1000 mm: 673336)  
 Separator inlet side AK R 5/6 (698006)  
 Oil mist filter FO R 2/2.5/5/6 (698003)  
 Package fine vacuum control KF DN 16 (683201)  
 Rubber vacuum tubing DN 8 mm (686001)  
 Small flange KF DN 16 with hose nozzle DN 8-10 mm (662806)

ORDERING INFORMATION		PC 3 / RZ 6
230 V ~ 50-60 Hz	CEE	699893

**ITEMS SUPPLIED**

Pump oil filled and completely mounted, ready for use, with manual.

\* With NRTL certification for Canada and the USA

\*\* Country specific power cable, please order separately if needed



- very high flow rates even at vacuum levels approaching ultimate vacuum
- high water vapor tolerance due to efficient gas ballast; very good ultimate vacuum even with gas ballast
- vacuum-tight at switch-off; external anti-suckback valve not needed
- large oil volume: Long intervals between oil changes
- ease of maintenance due to telescopic design



### RE 9 - RZ 9 - PUMPING UNIT PC 3 WITH RZ 9

The powerful mid-size one-stage RE 9 and two-stage RZ 9 rotary vane pumps are the ideal solution for a wide range of laboratory and process applications that require high pumping speed. The PC 3 rotary vane pumping unit, with the GKF 1000i cold trap at the inlet, helps the pump to handle large amounts of condensable vapors. The PC 3 pumping unit is compact, user-friendly, and well-arranged, with an oil mist filter at the outlet, a valve, and a T-connection for a vacuum gauge.

Pumping speed graph at 50 Hz  
with/without gas ballast

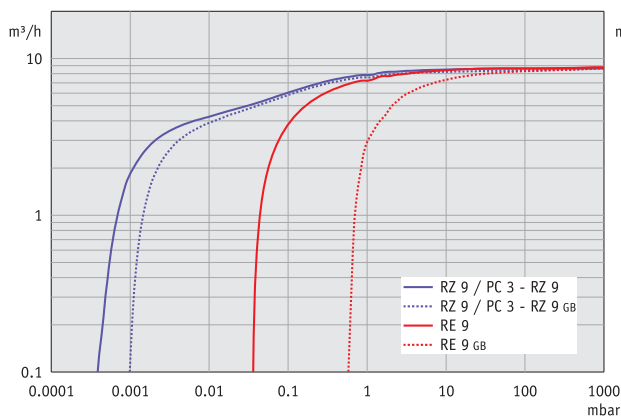

Pump down graph at 50 Hz  
with/without gas ballast  
(100 l volume)

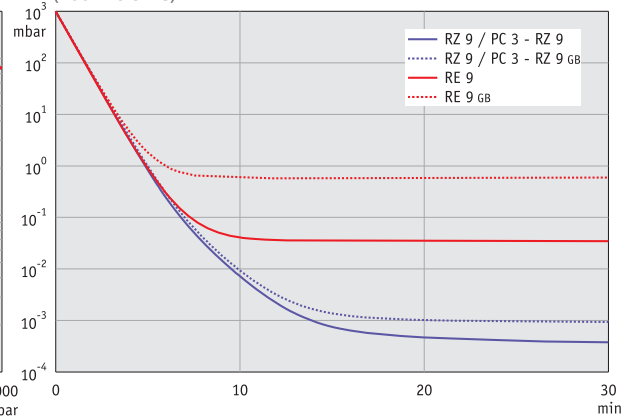

---

 ROTARY VANE PUMPS AND CHEMISTRY-HYBRID PUMPS
 

---

TECHNICAL DATA	RE 9	RZ 9
Number of stages	1	2
Max. pumping speed at 50/60 Hz	8.9 / 10.2 m <sup>3</sup> /h	8.9 / 10.2 m <sup>3</sup> /h
Ultimate partial vacuum (abs.)	1 x 10 <sup>-1</sup> mbar	4 x 10 <sup>-4</sup> mbar
Ultimate vacuum (abs.)	1 x 10 <sup>-1</sup> mbar	2 x 10 <sup>-3</sup> mbar
Ultim. vac. (abs.) with gas ballast	6 x 10 <sup>-1</sup> mbar	1 x 10 <sup>-2</sup> mbar
Water vapor tolerance with gas ballast	40 mbar	40 mbar
Oil capacity (B-Oil) min./max.	0.4 / 1.4 l	0.2 / 0.8 l
Inlet connection	Small flange KF DN 25	Small flange KF DN 25
Outlet connection	Small flange KF DN 25	Small flange KF DN 25
Rated motor power	0.37 kW	0.37 kW
Rated motor speed at 50/60 Hz	1500/1800 min <sup>-1</sup>	1500/1800 min <sup>-1</sup>
Degree of protection	IP 40	IP 40
Dimensions (L x W x H), approx.	460 x 152 x 232 mm	460 x 152 x 232 mm
Weight, approx.	21.4 kg	24.2 kg

**ORDERING INFORMATION** **RE 9**

230 V ~ 50-60 Hz	CEE	697170
------------------	-----	--------

**ORDERING INFORMATION** **RZ 9**

230 V ~ 50-60 Hz	CEE	698140
230 V ~ 50-60 Hz	CH, CN	698141
230 V ~ 50-60 Hz	UK, IN	698142
120 V ~ 60 Hz	US	698143
400 V ~ 50 Hz 3 Ph.	CEE	698145

**ACCESSORIES**

Stainless steel tubing KF DN 25 (1000 mm: 673337)  
 Separator inlet side AK R 8/9/16 (698007)  
 Oil mist filter FO R 8/9/16 (698017)  
 Inline oil filter HF R 8/9/16, until 06/2016 (698010)  
 Package fine vacuum control KF DN 25 (683202)

**ORDERING INFORMATION** **PC 3 / RZ 9**

230 V ~ 50-60 Hz	CEE	699895
------------------	-----	--------

**ITEMS SUPPLIED**

Pump oil filled and completely mounted, ready for use, with manual.

---

- reduced internal corrosion, even when working with corrosive vapors
- oil changes typically reduced 90% or more compared with rotary vane pumps alone
- excellent environmental friendliness due to efficient solvent recovery (accessory kit PC 8 with emission condenser; or as pumping unit PC 8)
- most economical solution: In practical operation a cold trap is often no longer necessary. For large amounts of vapors a pumping unit PC 3 / RC 6 with cold trap at the inlet is available
- ease of maintenance due to telescopic design

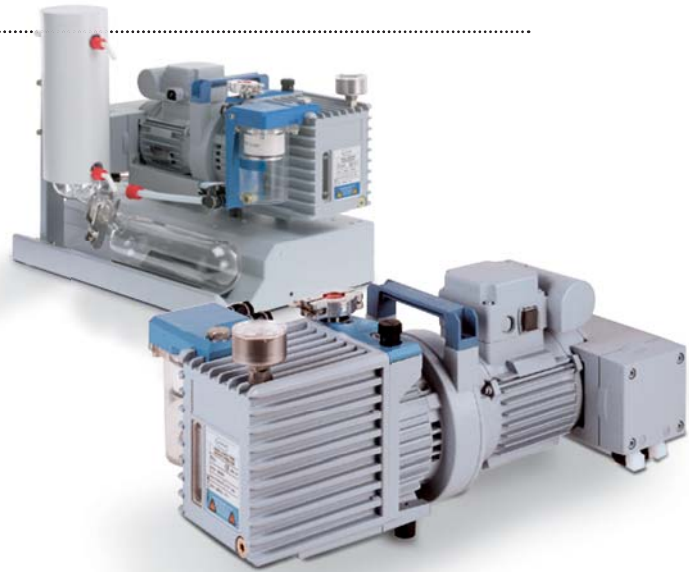

### RC 6 - PC 8 WITH RC 6

The RC 6 chemistry-HYBRID pump is a combination of a two-stage rotary vane pump and a two-stage chemistry diaphragm pump for optimized corrosion resistance. The diaphragm pump maintains the oil reservoir under vacuum in order to keep the partial pressures of solvent vapors at levels below their condensation points and to reduce largely the concentration of oxygen and corrosive gases. Therefore the RC 6 chemistry-HYBRID pump has a much higher solvent vapor pumping capability and resistance to aggressive gases than conventional rotary vane pumps. The pumping unit version PC 8 with RC 6 offers excellent environmental friendliness due to efficient solvent recovery.

Pumping speed graph at 50 Hz  
with/without gas ballast

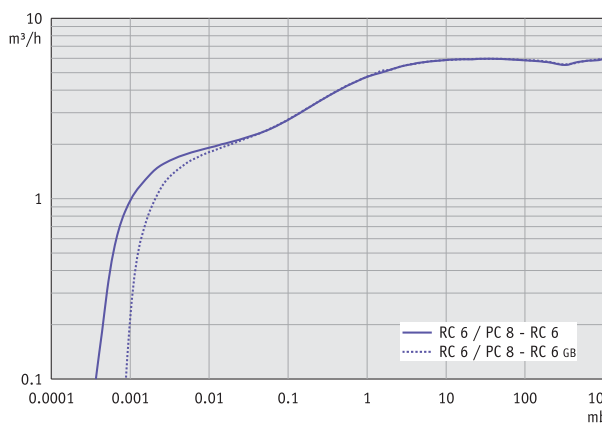

Pump down graph at 50 Hz  
with/without gas ballast  
(10 l volume)

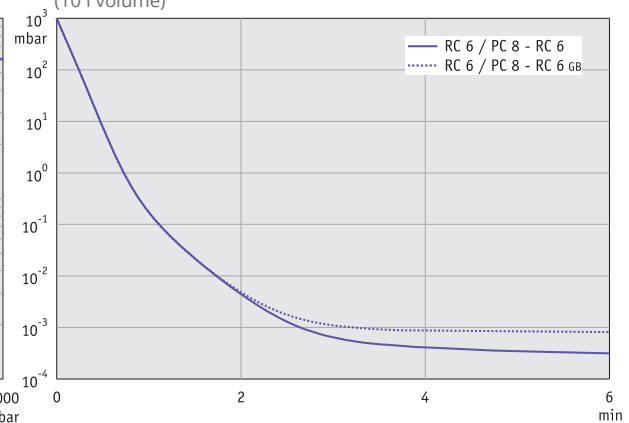

## ROTARY VANE PUMPS AND CHEMISTRY-HYBRID PUMPS

### THERMODYNAMIC FUNCTIONAL PRINCIPLE OF THE CHEMISTRY-HYBRID PUMP

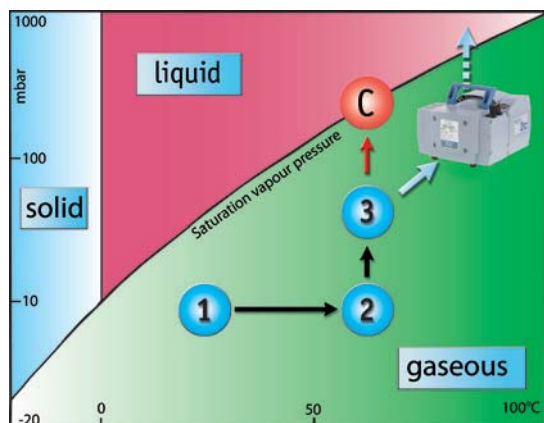

1 - Vapor is aspirated at low pressure and ambient temperature.

2 - Vapor is heated to approx. 60°C by heat exchange and compression within pump.

C - Condensation problem with "normal" rotary-vane pumps: On the way to atmospheric pressure, the saturation vapor pressure (transition to liquid state) is reached **inside** the oil-filled section. Result: **Condensation** and **corrosion** inside the pump; **contamination** of the oil.

3 - Chemistry-HYBRID Pump: The chemistry diaphragm pump evacuates the vapors from the oil reservoir of the rotary-vane pump. Under intended operating conditions, **no condensation** takes place inside the oil-filled part and, in particular, within the oil reservoir. (Any condensation taking place inside the oil-free diaphragm pump is much less problematic.) Less condensation means **less corrosion** and **cleaner oil for longer life**. For example, in the case of acid vapors, the evacuation of the oil reservoir to 20 mbar reduces corrosion by a factor of about 50!

### TECHNICAL DATA

RC 6

Number of stages	2 + 2
Max. pumping speed at 50/60 Hz	5.9 / 6.9 m <sup>3</sup> /h
Ultimate partial vacuum (abs.)	4 x 10 <sup>-4</sup> mbar
Ultimate vacuum (abs.)	2 x 10 <sup>-3</sup> mbar
Ultim. vac. (abs.) with gas ballast	1 x 10 <sup>-2</sup> mbar
Water vapor tolerance with gas ballast	>> 40 mbar
Oil capacity (B-Oil) min./max.	0.34 / 0.53 l
Inlet connection	Small flange KF DN 16
Outlet connection	Hose nozzle DN 8-10 mm
Rated motor power	0.37 kW
Rated motor speed at 50/60 Hz	1500/1800 min <sup>-1</sup>
Degree of protection	IP 40
Dimensions (L x W x H), approx.	510 x 305 x 230 mm
Weight, approx.	24.2 kg

### ACCESSORIES

PTFE tubing KF DN 16 (1000 mm: 686031)  
 Stainless steel tubing KF DN 16 (1000 mm: 673336)  
 Kit PC 8 with emission condenser (699949)  
 Filter element oil mist filter RC (640187)  
 Package fine vacuum control KF DN 16 (683201)  
 Rubber vacuum tubing DN 8 mm (686001)  
 Small flange KF DN 16 with hose nozzle DN 8-10 mm (662806)

### ITEMS SUPPLIED

Pump completely mounted, ready for use after oil filling (bottle 0.5 l enclosed), with manual.

### ORDERING INFORMATION

RC 6

230 V ~ 50-60 Hz	CEE	698560
230 V ~ 50-60 Hz	CH	698561
230 V ~ 50-60 Hz	UK, IN	698562
100-120 V ~ 50-60 Hz	US	698563
230 V ~ 50-60 Hz	CEE/CN	698566

### ORDERING INFORMATION

PC 3 / RC 6

230 V ~ 50-60 Hz	*2613307
------------------	----------

### ORDERING INFORMATION

PC 8 / RC 6

230 V ~ 50-60 Hz	CEE	698570
------------------	-----	--------

\* Please order power cable separately

## OILS FOR ROTARY VANE PUMPS

**Oils for rotary vane pumps have to meet high requirements, especially in circumstances of continuous operation:**

- ✦ low vapor pressure even at high temperatures
- ✦ excellent lubricating properties
- ✦ low oil back streaming
- ✦ excellent resistance to aging
- ✦ resistant to break-down
- ✦ minimum oxidation



### Rotary-vane Pump Oil B

This vacuum pump oil has excellent viscosity characteristics. Its good chemical resistance, low vapor pressure as well as its better stability when pumping oxidants such as acid and alkaline vapors, makes it superior compared to standard mineral oils. This oil is used for the first filling of RE / RZ / RC series pumps.

Many pumped substances can cause deterioration of common pump oil, leading to mechanical problems. **Special oils** should be used as a prevention. **Special oils may maintain lubricating properties but provide only limited protection against corrosion. The start of the pumps at low temperatures can be impeded.**

### Rotary-vane Pump Oil K 8

This oil is especially designed for pumping acid vapors but is very hygroscopic and has limited capacity for water vapor. The alkaline additive is consumed during operation making it necessary to change the fluid regularly - even if the pump is not used for several days. Pump oil K 8 does not have the low vapor pressure and the viscosity characteristics of pump oil type B. Pumps will therefore not reach the specified ultimate vacuum and may not start up well at temperatures < 18°C.

### Perfluoropolyether Oil

This synthetic oil has excellent chemical resistance. Therefore it is often used for pumping strong oxidants (halogenides, nitrogen oxides, etc.). As this oil type must not be mixed with mineral oils, a pump intended for this oil should be built with it from the outset. All VACUUBRAND rotary vane pumps are available with this oil on request. For changeover of an existing pump to this oil the pump has to be completely disassembled, cleaned and refilled with perfluoropolyether oil at VACUUBRAND (on request).

PFPE oil type I for VACUUBRAND rotary vane pumps RE 2.5, RZ 2.5, RE 6, RZ 6.

PFPE oil type II for all VACUUBRAND rotary vane pumps.

---

 ROTARY VANE PUMPS AND CHEMISTRY-HYBRID PUMPS
 

---

TECHNICAL DATA	ROTARY-VANE PUMP OIL B	ROTARY-VANE PUMP OIL K 8
Vapor pressure (mbar) at operating temperature of pump	$< 1 \times 10^{-3}$	$< 5 \times 10^{-3}$
Flashpoint °C	264	249
Viscosity at 40°C mm <sup>2</sup> /sec	94	128
Density at 20°C g/cm <sup>3</sup>	0.87	0.89

TECHNICAL DATA	PERFLUOROPOLYETHER OIL TYP I	PERFLUOROPOLYETHER OIL TYP II
Vapor pressure (mbar) at operating temperature of pump	$< 3 \times 10^{-5}$	$< 3 \times 10^{-5}$
Flashpoint °C	-	-
Viscosity at 40°C mm <sup>2</sup> /sec	60	60
Density at 20°C g/cm <sup>3</sup>	1.90	1.89

**ORDERING INFORMATION**

Pump oil B, 1 l bottle	687010	Rotary-vane pump oil K8, 5 l canister	687101
Pump oil B, 5 l canister	687011	Rotary-vane pump oil K8, 20 l canister	687102
Pump oil B, 20 l canister	687012	Perfluoropolyether oil I, 0.3 l bottle	687610
Pump oil B, 200 l barrel	687013	Perfluoropolyether oil II, 0.5 l bottle	687600
Rotary-vane pump oil K8, 1 l bottle	687100		

**PROTECT YOUR PUMP AND THE ENVIRONMENT...**
**...AT INLET (OF PUMP)**
**Cold traps (models SKF and GKF)**

Cold traps filled with cooling agents, such as dry ice or liquid nitrogen, separate condensate and aggressive media and protect highly efficient\*. In addition cold traps filled with liquid nitrogen reduce back-migration of oil vapors considerably. Cold traps improve the effective pumping speed for condensable media significantly.

\* Efficient only for inlet pressures  $< 1$  mbar.

**Separator (AK)**

Separators at the inlet protect pumps from particulates and droplets which may shorten service intervals and even reduce the lifetime and the operating performance of oil-sealed rotary vane pumps.

- ◆ direct mounting at the inlet, compact and leak-tight
  - ◆ high conductance
  - ◆ direct visibility of condensate through the transparent catchpot
  - ◆ easy draining of condensate
-



## ...AT OUTLET (OF PUMP)

### Oil mist filter (FO)

Exhaust gases from oil-sealed rotary vane pumps always carry a certain quantity of oil mist. This is extremely unpleasant, and even harmful, for those working nearby. VACUUBRAND oil mist filters separate nearly 100% of oil mist at the ultimate vacuum of the pump.

- ◆ very high degree of separation
- ◆ optimal control by transparent catchpot
- ◆ easy draining of oil
- ◆ direct mounting on the oil reservoir outlet
- ◆ integrated pressure relief valve for burst protection in case of blocked filter

## ...IN THE PUMP

### Oil return upgrade kit for R 2.5/6/9 (R 16 on request), for installation on existing oil mist filter FO

The oil return kit puts the oil collected in the oil mist filter back into the oil circuit of the vacuum pump.

- ◆ for operation at relatively high vacuum pressure or frequently aerating of the vacuum chamber
- ◆ recommended for applications with low oil contamination

### Full-flow oil filter (HF, only for R 8/9/16 until manufacturing date 06/2016 )

Particles reduce the lifetime of the oil and increase service demands. The full-flow oil filters efficiently filter micro particles out of the oil. The service indicator helps to avoid unnecessary filter changes.

### Tips to obtain the best vacuum

- ◆ use a suction line with maximum cross-section (corresponding to the pump inlet). With a smaller cross section than the pump inlet the pumping speed especially at low pressures might be severely limited.
  - ◆ design the suction line between the application and the pump as short as possible. The hose length and type has a major influence on the effective pumping speed at the application.
  - ◆ for high demands on chemical resistance we recommend corrugated PTFE hoses
-

- ◆ direct mounting at the inlet, compact and leak-tight
- ◆ high conductance
- ◆ direct visibility of condensate through the transparent catchpot
- ◆ easy draining of condensate



## SEPARATOR (AK)

Separators at the inlet protect pumps from particulates and droplets which may shorten service intervals and even reduce the lifetime and the operating performance of oil-sealed rotary vane pumps.

TECHNICAL DATA		AK R 2/2.5	AK R 5/6	AK R 8/9/16
Inlet		Small flange KF DN 16	Small flange KF DN 16	Small flange KF DN 25
Outlet		directly mountable	directly mountable	directly mountable
Wetted materials		Aluminum, PMP	Aluminum, PMP	Aluminum, PMP
Volume catchpot	ml	250	250	500
Dimensions (L x W x H), approx.	mm	200 x 80 x 159	223 x 80 x 159	163 x 110 x 161
Weight, approx.	kg	0.65	0.7	1.1
For VACUUBRAND pumps		RE 2, RZ 2, RE 2.5, RZ 2.5	RE 5, RZ 5, RE 6, RZ 6	RE 8, RZ 8, RE 9, RZ 9, RE 16, RZ 16

### ORDERING INFORMATION

AK R 2/2.5	698000
AK R 5/6	698006
AK R 8/9/16	698007

## SEPARATORS AND OIL MIST FILTERS

- very high degree of separation
- optimal control by transparent catchpot
- easy draining of oil
- direct mounting on the oil reservoir outlet
- integrated pressure relief valve for burst protection in case of blocked filter



## OIL MIST FILTER (FO)

Exhaust gases from oil-sealed rotary vane pumps always carry a certain quantity of oil mist. This is extremely unpleasant, and even harmful, for those working nearby. VACUUBRAND oil mist filters separate nearly 100% of oil mist at the ultimate vacuum of the pump.

TECHNICAL DATA	FO R 2/2.5/5/6	FO R 8/9/16
Inlet	directly mountable	directly mountable
Outlet	Hose nozzle DN 10 mm	Small flange KF DN 25
Permissible volume flow rate	m <sup>3</sup> /h 6	20
Wetted materials	Aluminum, PMP, fiberglass epoxy	Aluminum, PMP, fiberglass epoxy
Max. collecting volume	ml 180	195
Dimensions (L x W x H), approx.	mm 119 x 80 x 181	163 x 110 x 196
Weight, approx.	kg 0.8	1.3
For VACUUBRAND pumps	RE 2, RZ 2, RE 2.5, RZ 2.5, RE 5, RZ 5, RE 6, RZ 6	RE 8, RZ 8, RE 9, RZ 9, RE 16, RZ 16

## ORDERING INFORMATION

FO R 2/2.5/5/6	698003
FO R 8/9/16	698017

## COLD TRAPS AND INLINE OIL FILTER

**SKF**

- ✦ sturdy, easy to clean
- ✦ easy to disassemble
- ✦ two-wall design with good conductance
- ✦ long operating time per coolant filling
- ✦ easy condensate drainage without disassembling

**GKF**

- ✦ highly reflective insulation jacket for extended coolant life
- ✦ vertical window: Direct observation of condensate and coolant levels
- ✦ PTFE stopcock: Drain condensate without disassembly
- ✦ sheet metal shield for protection against external damage and implosion



## COLD TRAPS SKF - GKF

At inlet pressures below 1 mbar cold traps using dry ice or liquid nitrogen as coolant provide important protection for your pump by separating condensates and aggressive media. Cold traps using liquid nitrogen may be essential with very volatile solvents and reduce the back streaming of oil molecules into the vacuum system. Furthermore a cold trap will considerably increase the effective pumping speed for vapors.

TECHNICAL DATA	SKF H 25	SKF H 40	GKF 1000i
Inlet	Small flange KF DN 25	Small flange KF DN 40	NS 29/32 female ground joint
Outlet	Small flange KF DN 25	Small flange KF DN 40	Glass tube 22 mm
Materials	Stainless steel, FKM, NBR	Stainless steel, FKM, NBR	Borosilicate glass, PTFE, FKM
Volume catchpot	ml	500	500
Coolant capacity	ml	1000	1000
Typ. coolant life*		12 h	12 h
Dimensions (L x W x H), approx.	mm	166 x 140 x 303	166 x 140 x 319
			D148 x 580

**TECHNICAL DATA FULL-FLOW OIL FILTER (HF, ONLY FOR R 8/9/16 UNTIL MANUFACTURING DATE 06/2016 )**

Additional oil amount	0.35 l
For VACUUBRAND pumps	RE 8, RZ 8, RE 9, RZ 9, RE 16, RZ 16

**ORDERING INFORMATION**

Cold trap SKF H 25	667051
Cold trap SKF H 40	667053
Cold trap GKF 1000i	667056
Inline oil filter HF R 8/9/16	**698010
Spare filter element HF R 8/9/16	**698011
Adapter KF DN 16 / tube OD 22 mm (for GKF 1000i)	667057

\* typical coolant change intervall for liquid N<sub>2</sub> at pressure < 10<sup>-2</sup> mbar and 20°C ambient temperature

\*\* Full-flow oil filter (HF, only for R 8/9/16 until manufacturing date 06/2016 )